

IT BATTISCOPIA FILOMURO FR PLINTE À FIL DE CLOISON ES RODAPIÉ RAS DE PARED EN FLUSH-FITTING SKIRTING BOARD

IT ISTRUZIONI DI MONTAGGIO PER PARETI INTONACO E CARTONGESSO
FR INSTRUCTIONS DE MONTAGE POUR MURS ENDUIT ET PLAQUES DE PLÂTRE
ES INSTRUCCIONES DE MONTAJE PARA PAREDES DE ENLUCIDO Y CARTÓN YESO
EN ASSEMBLY INSTRUCTIONS FOR PLASTER AND PLASTERBOARD WALLS

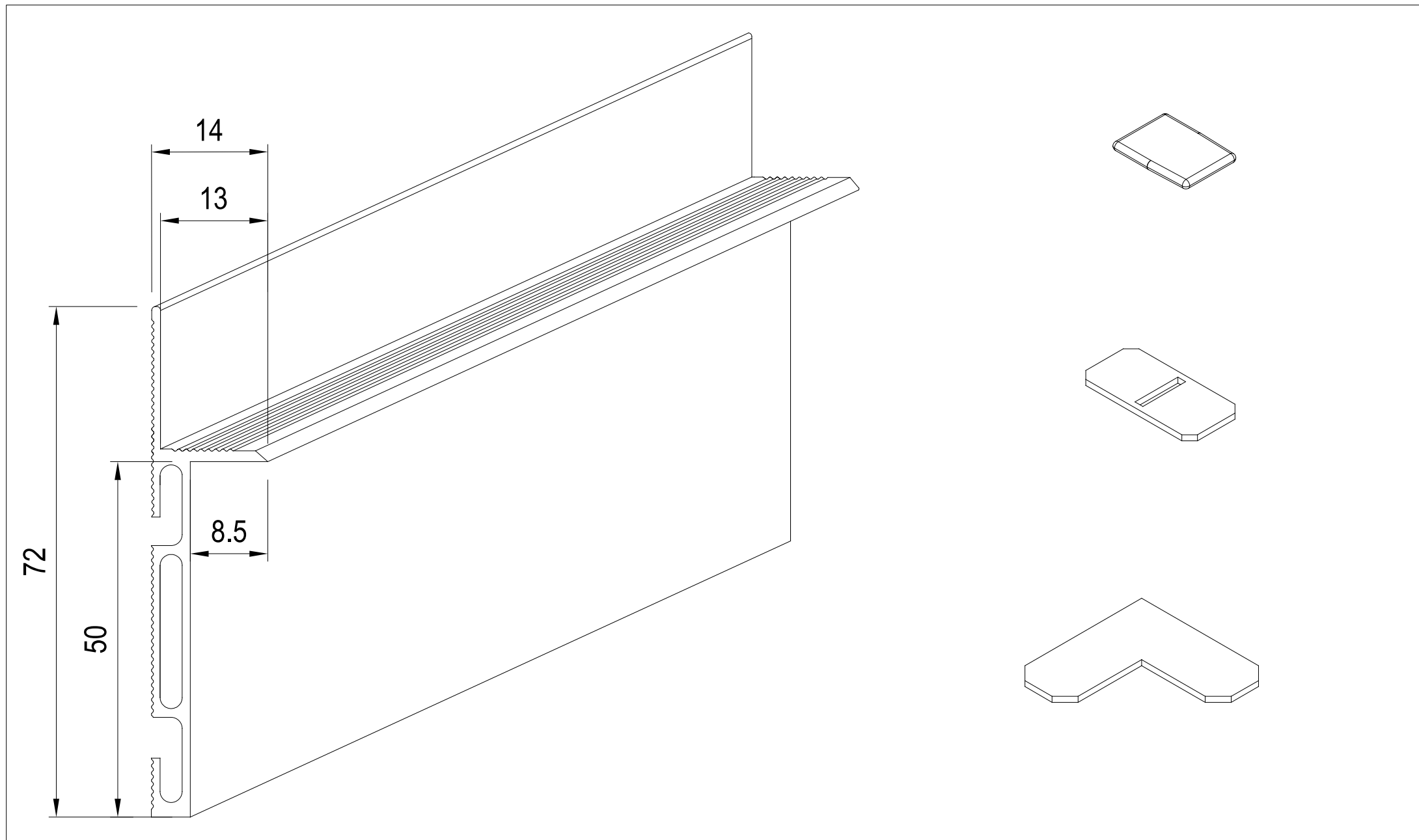

ATTREZZATURA NECESSARIA
ÉQUIPEMENT NÉCESSAIRE
HERRAMIENTA NECESARIA
NECESSARY EQUIPMENT

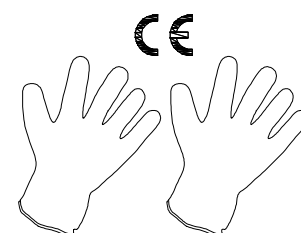
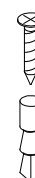
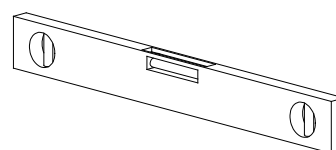
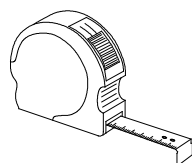
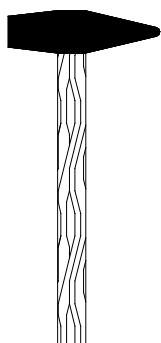
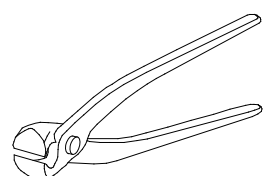
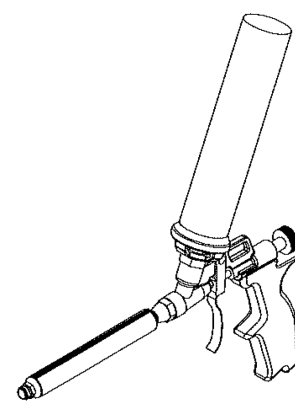
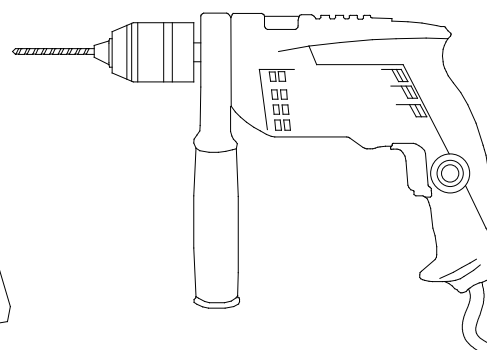
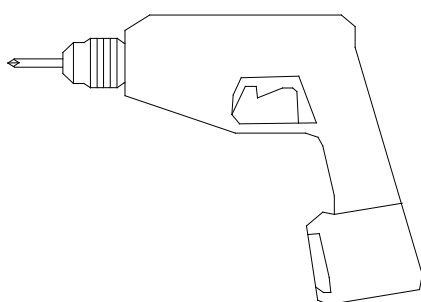
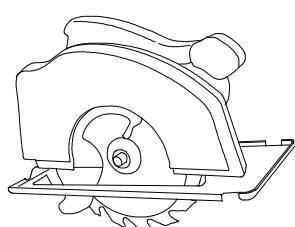
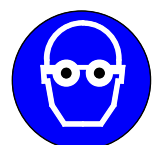
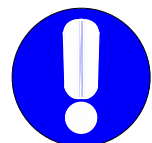

I dati pubblicati sono indicativi. Scrigno S.p.A. declina ogni responsabilità per le possibili inesattezze contenute, dovute ad errori di stampa, di trascrizione o per qualsiasi altro motivo e si riserva il diritto di apportare modifiche atte a migliorare i prodotti senza preavviso. La riproduzione anche parziale è severamente vietata a norme di legge.

Ces informations sont remises a titre indicatif. SCRIGNO S.p.A. decline toute responsabilité en cas d'erreur d'impression, de traduction, ou pour tout autre motif. Elle se réserve le droit d'apporter toute modification pour le montage et l'amélioration du produit sans préavis. Toute reproduction même partielle de ce document est formellement interdite.

Los datos publicados son orientativos. Scrigno S.p.A. declina toda responsabilidad por las inexactitudes que pueda contener el texto, debidas a errores de imprenta, de transcripción o a cualquier otro motivo y se reserva el derecho de introducir modificaciones dirigidas a mejorar los productos sin previo aviso. De conformidad con las normas legales, queda terminantemente prohibida la reproducción total o parcial.

The information given in this document is for descriptive purposes only. SCRIGNO S.p.A. will not be held responsible for any inaccuracies caused by printing errors, transcription errors or for any other reason, and reserves the right to make modifications, without giving prior notice, for the improvement of its products. The reproduction, including the partial reproduction, of this document is severely prohibited within the terms of the Law.

SCRIGNO

Scrigno SpA | scrigno.net
via Casale Sant'Ermete 975
47822 Santarcangelo di Romagna (RN)
ph. + 39 0541 757711 fax + 39 0541 757780
scrigno@scrigno.it

COMPONENTI VENDUTI SEPARATAMENTE
 COMPOSANTS VENDUS SÉPARÉMENT
 COMPONENTES VENDIDOS POR SEPARADO
 COMPONENTS SOLD SEPARATELY

MOD. A (STANDARD)

2 pz. L=2000mm
 2 pces L=2000mm
 2 uds. L=2000 mm
 2 pcs. L=2000 mm

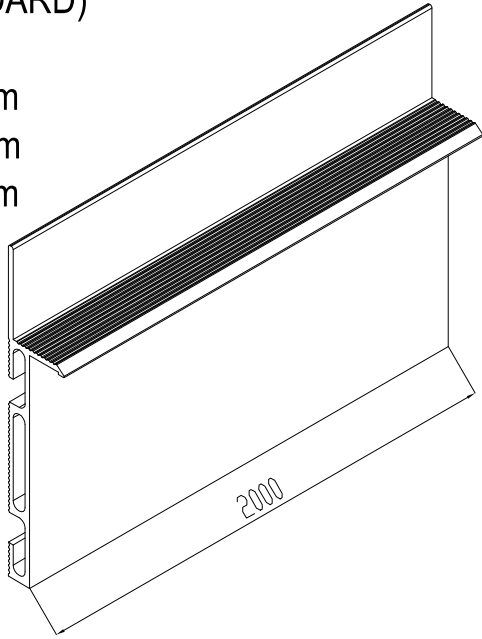

GIUNTO LINEARE (D) 10 pz
 RACCORD LINÉAIRE (D) 10 pces
 UNIÓN LINEAL (D) 10 uds.
 LINEAR JOINT (D) 10 pcs.

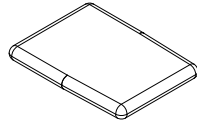

GIUNTO x GRADINI (E) 10 pz
 RACCORD pour MARCHES (E) 10 pces
 UNIÓN para PELDAÑOS (E) 10 uds.
 JOINT FOR STEPS (E) 10 pcs.

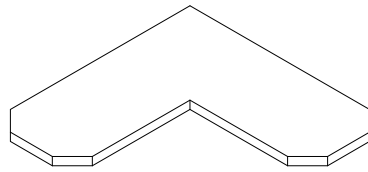

GIUNTO VARIABILE A PIEGARE (F) 10 pz
 RACCORD VARIABLE PLIABLE (F) 10 pces
 UNIÓN VARIABLE DE PLEGAR (F) 10 uds.
 VARIABLE BENDING JOINT (F) 10 pcs.

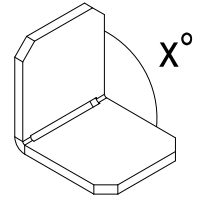
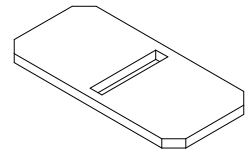

MOD. B

2 pz. L=2000mm
 2 pces L=2000mm
 2 uds. L=2000 mm
 2 pcs. L=2000 mm

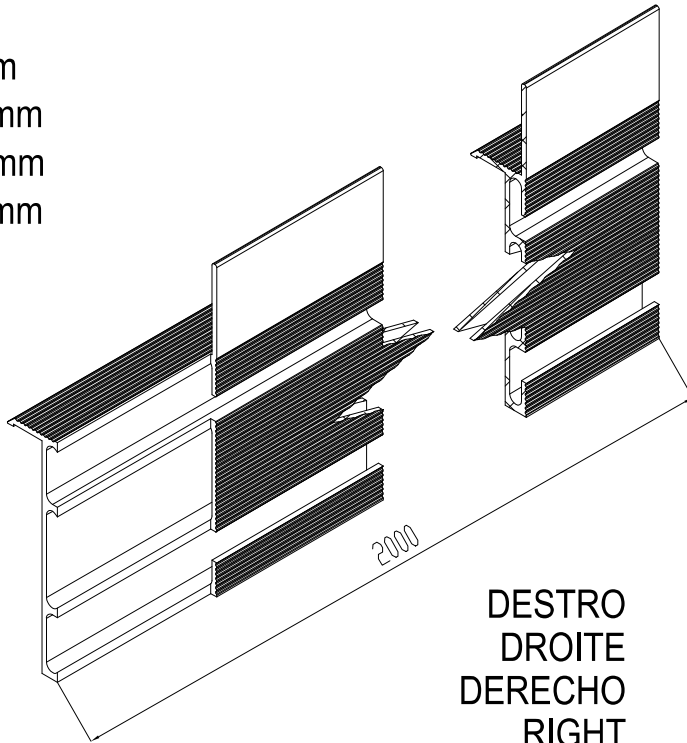

DESTRO
 DROITE
 DERECHO
 RIGHT

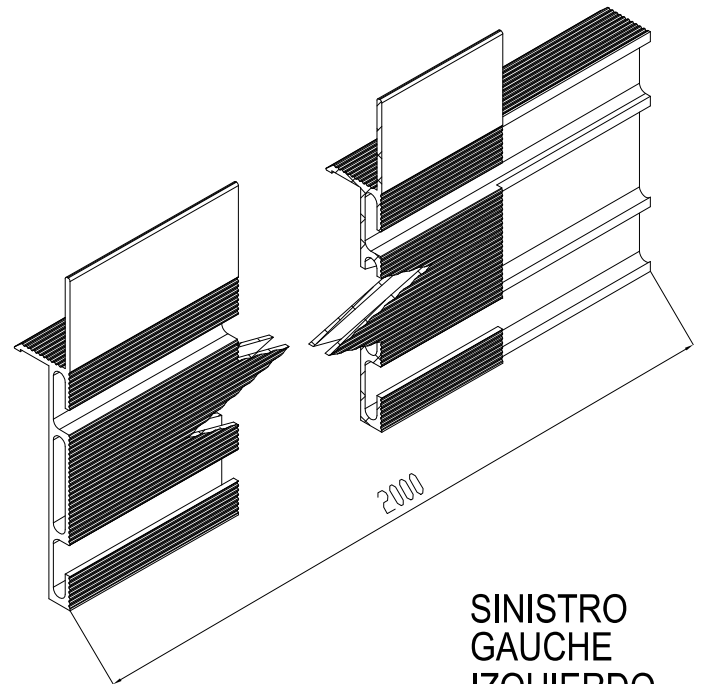

SINISTRO
 GAUCHE
 IZQUIERDO
 LEFT

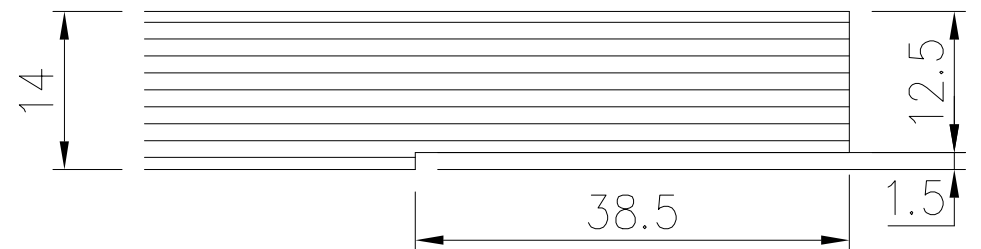
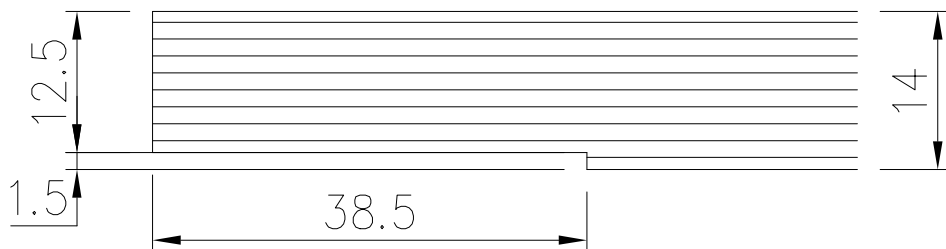

MOD. C

2 pz. L=2000mm
 2 pces L=2000mm
 2 uds. L=2000 mm
 2 pcs. L=2000 mm

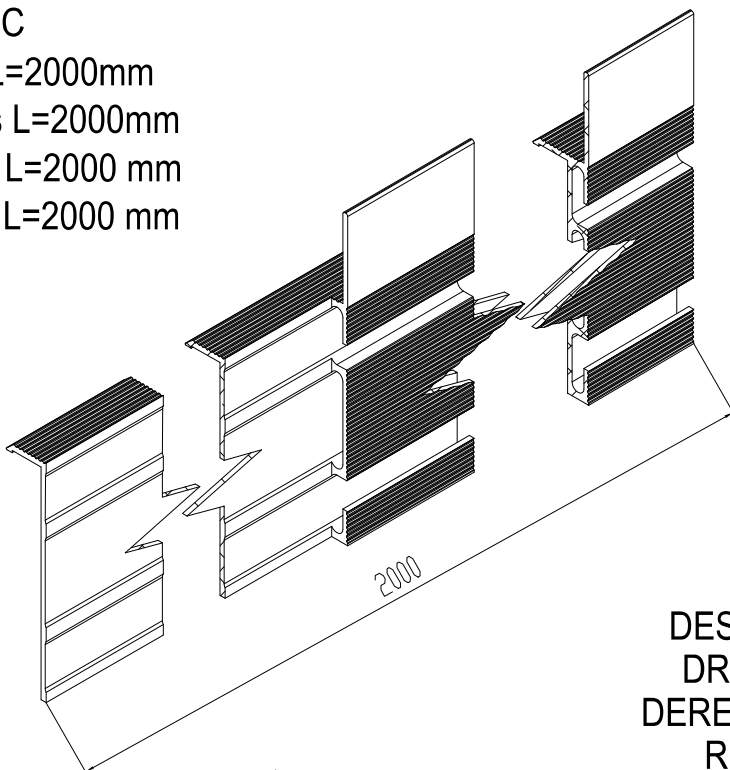

DESTRO
 DROITE
 DERECHO
 RIGHT

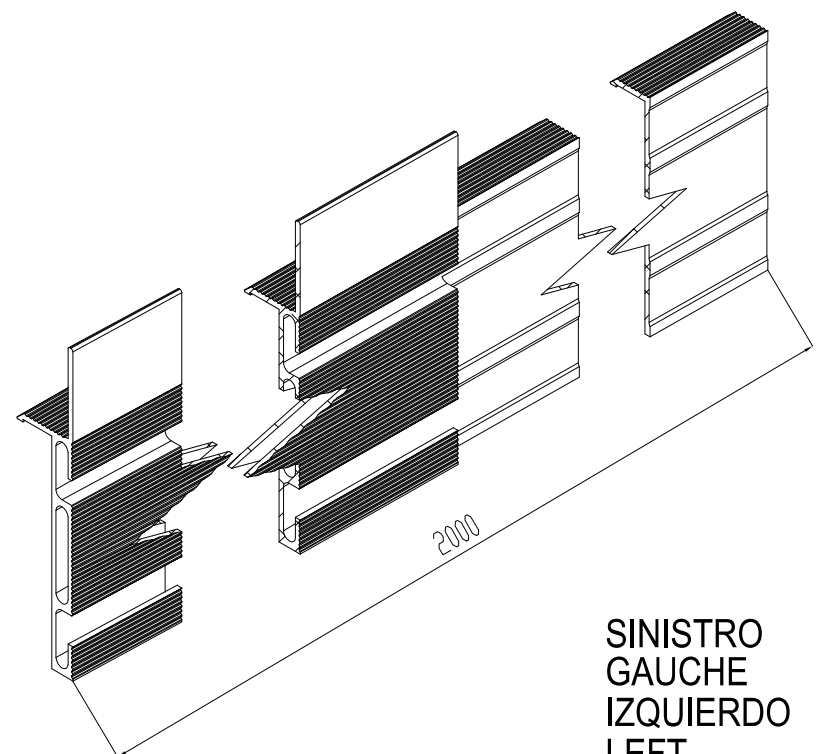

SINISTRO
 GAUCHE
 IZQUIERDO
 LEFT

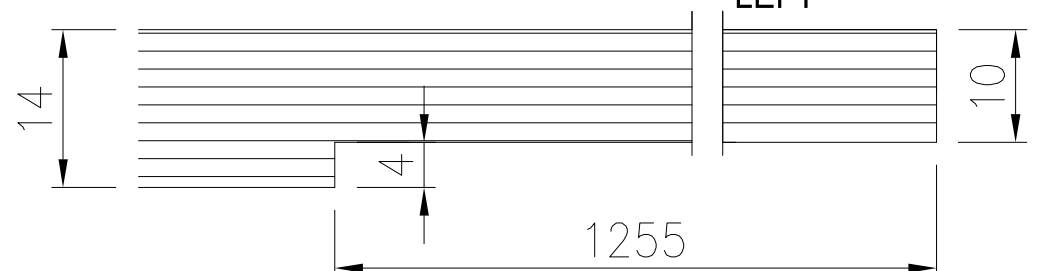
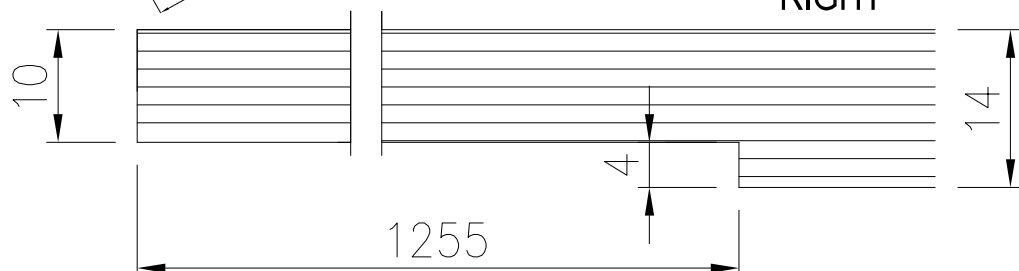

MONTAGGIO SU MURATURA
MONTAGE SUR CLOISONS EN BRIQUES
MONTAJE EN MAMPOSTERÍA
ASSEMBLY ON MASONRY

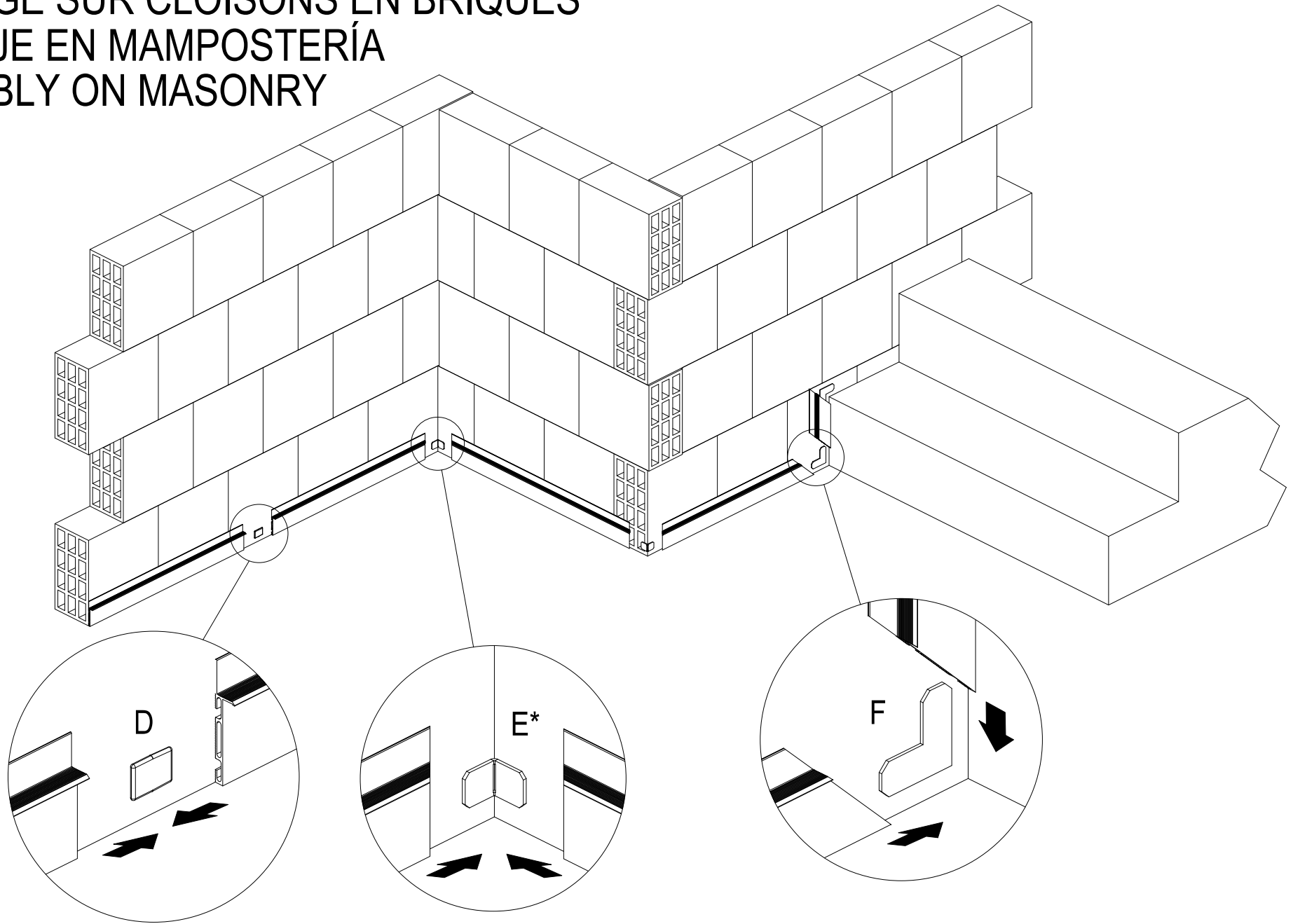

- * IL GIUNTO VARIABILE "E" PERMETTE LA REALIZZAZIONE DI QUALSIASI TIPO DI ANGOLO
- * LE RACCORD VARIABLE « E » PERMETT DE RÉALISER N'IMPORTE QUEL TYPE D'ANGLE
- * CON LA UNIÓN VARIABLE "E" SE PUEDE REALIZAR CUALQUIER TIPO DE ESQUINA
- * VARIABLE JOINT "E" IS DESIGNED TO ACCOMPLISH ANY TYPE OF CORNER

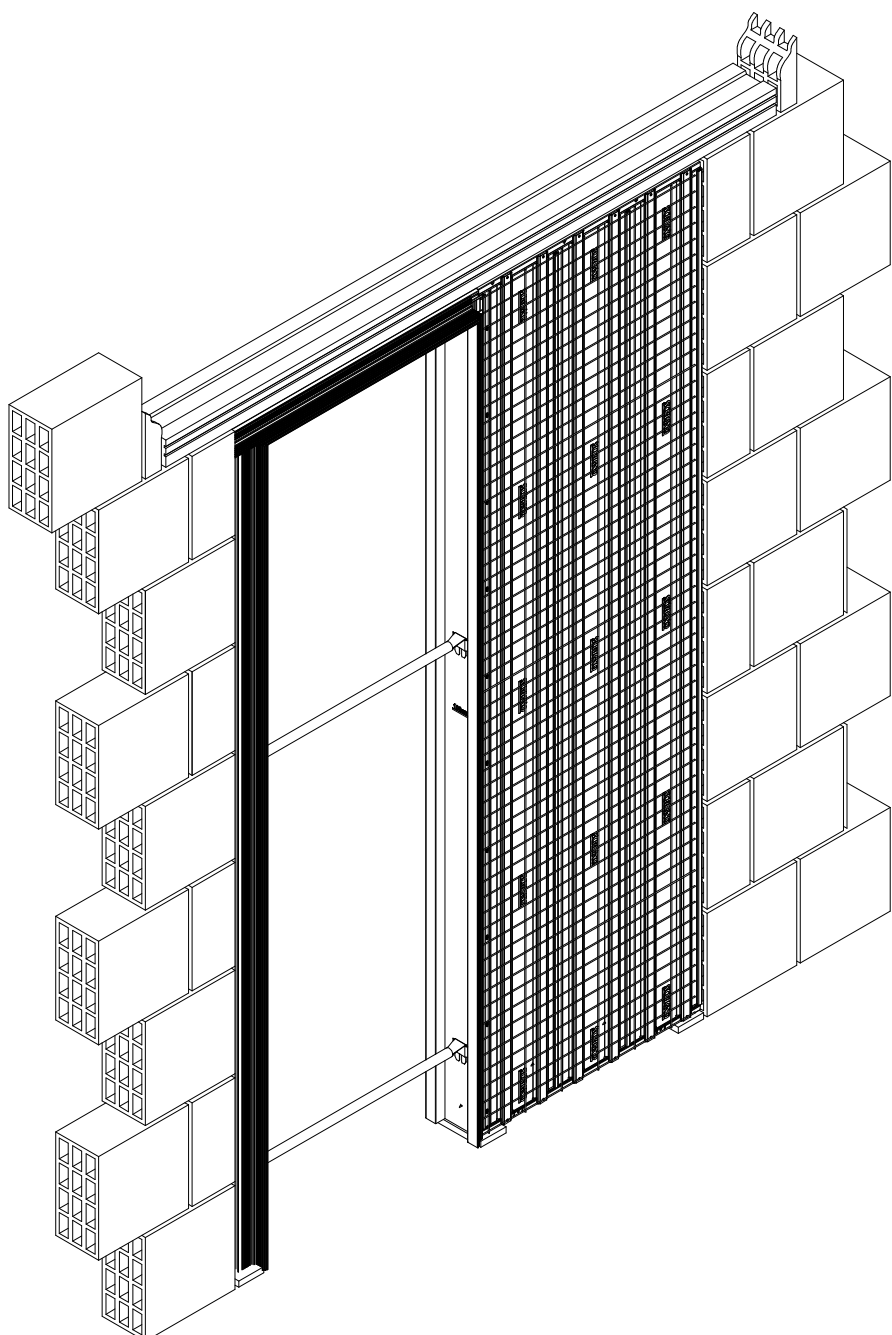

PER TUTTI GLI ANGOLI TAGLIARE I PROFILI A 46°
 POUR TOUS LES ANGLES, COUPER LES PROFILÉS À 46°
 PARA TODAS LAS ESQUINAS CORTAR LOS PERFILES A 46°
 FOR ALL CORNERS CUT THE PROFILES AT 46°

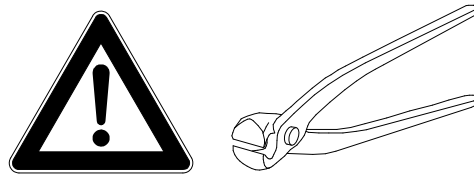

PER IL MONTAGGIO SU CASSONETTO DA INTONACO E' NECESSARIO TAGLIARE LA RETE NELLA PARTE INFERIORE PER UN'ALTEZZA DI 75mm

POUR LE MONTAGE SUR CAISSON D'ENDUIT, IL FAUT COUPER LE GRILLAGE DANS LA PARTIE INFÉRIEURE POUR UNE HAUTEUR DE 75mm

PARA EL MONTAJE EN ARMAZÓN DE ENLUCIDO ES NECESARIO CORTAR UNA ALTURA DE 75 mm EN LA PARTE INFERIOR DE LA MALLA

FOR ASSEMBLY ON A PLASTER CASE, THE LOWER PART OF THE MESH MUST BE CUT FOR A HEIGHT OF 75mm

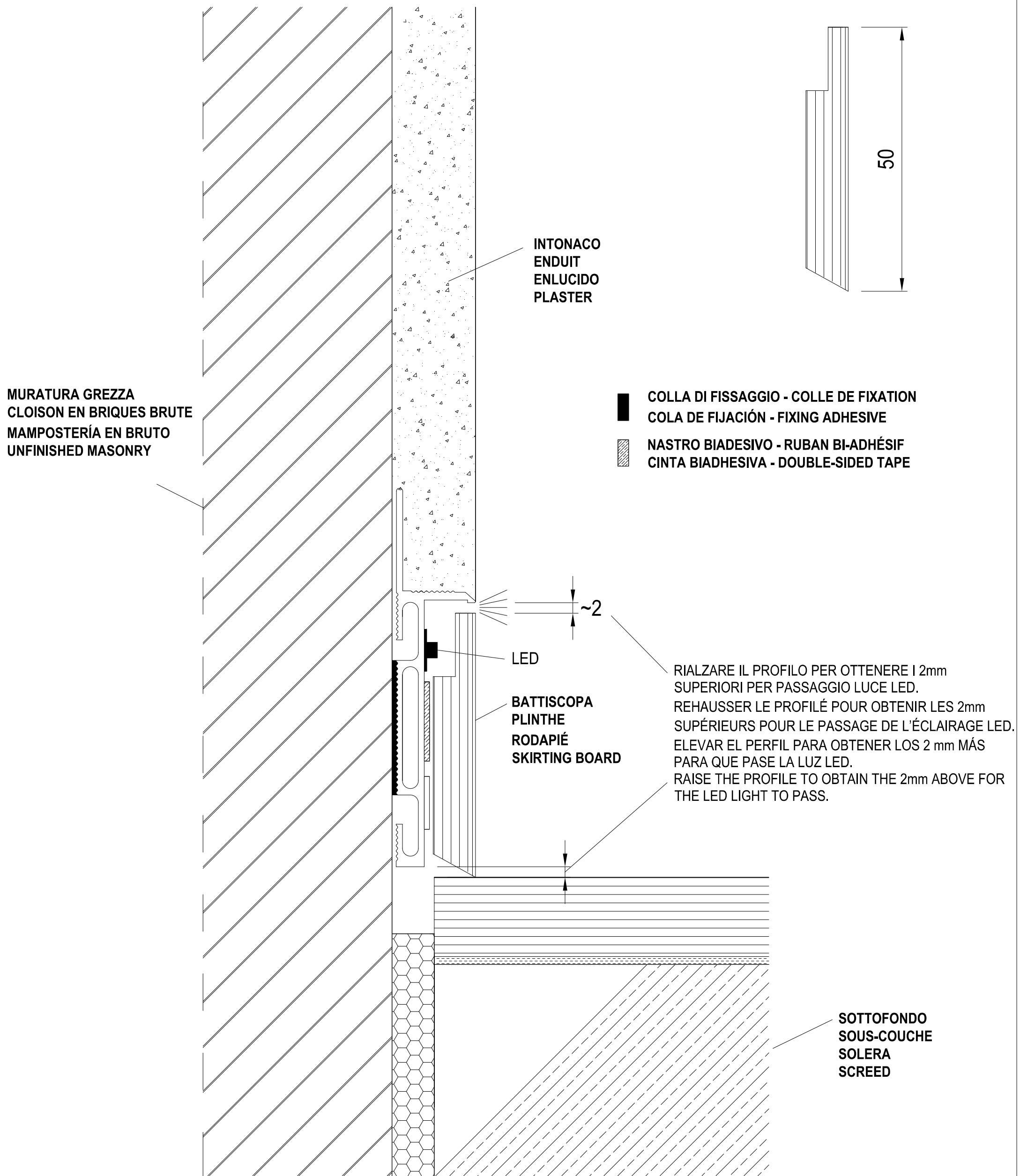

PER BATTISCOPIA PIÙ ALTI POSIZIONARE IL PROFILO DI ALLUMINIO AD UNA QUOTA PIÙ ELEVATA
 POUR LES PLINTHES PLUS HAUTES, PLACER LE PROFILÉ EN ALUMINIUM À UNE HAUTEUR PLUS ÉLEVÉE
 PARA RODAPIÉS MÁS ALTOS, COLOCAR EL PERFIL DE ALUMINIO A MAYOR ALTURA
 FOR HIGHER SKIRTING BOARDS, PLACE THE ALUMINIUM PROFILE IN A HIGHER POSITION

MONTAGGIO CON CARTONGESSO
MONTAGE AVEC PLAQUES DE PLÂTRE
MONTAJE CON CARTÓN YESO
ASSEMBLY ON PLASTERBOARD

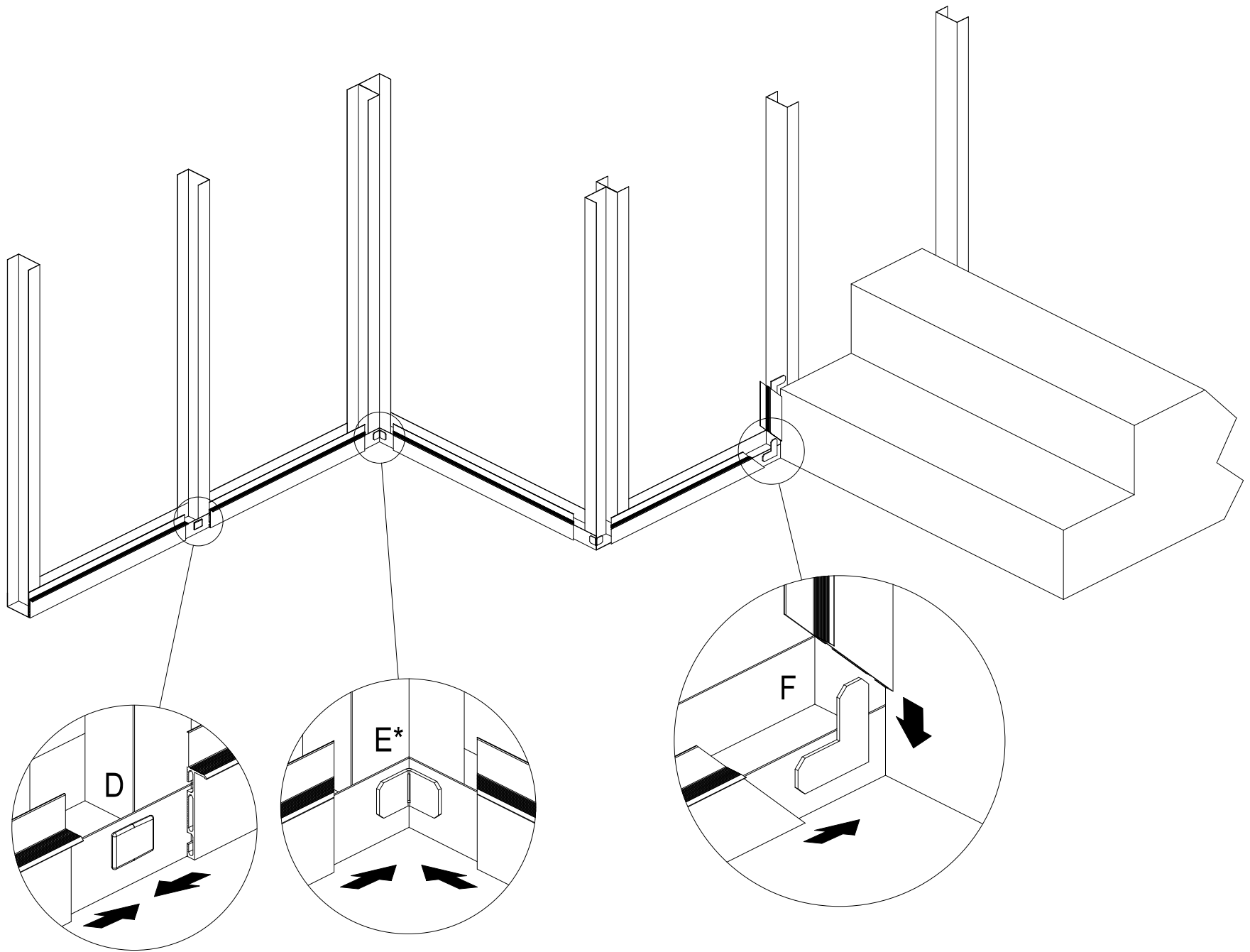

- * IL GIUNTO VARIABILE "E" PERMETTE LA REALIZZAZIONE DI QUALSIASI TIPO DI ANGOLO
- * LE RACCORD VARIABLE « E » PERMET DE RÉALISER N'IMPORTE QUEL TYPE D'ANGLE
- * CON LA UNIÓN VARIABLE "E" SE PUEDE REALIZAR CUALQUIER TIPO DE ESQUINA
- * VARIABLE JOINT "E" IS DESIGNED TO ACCOMPLISH ANY TYPE OF CORNER

PER TUTTI GLI ANGOLI TAGLIARE I PROFILI A 46°
POUR TOUS LES ANGLES, COUPER LES PROFILÉS À 46°
PARA TODAS LAS ESQUINAS CORTAR LOS PERFILES A 46°
FOR ALL CORNERS CUT THE PROFILES AT 46°

MONTAGGIO CON CARTONGESSO LASTRA SINGOLA
MONTAGE AVEC PLAQUES DE PLAQUES DE PLÂTRE PLAQUE SIMPLE
MONTAJE CON CARTÓN YESO UNA PLACA
ASSEMBLY ON SINGLE PANE PLASTERBOARD

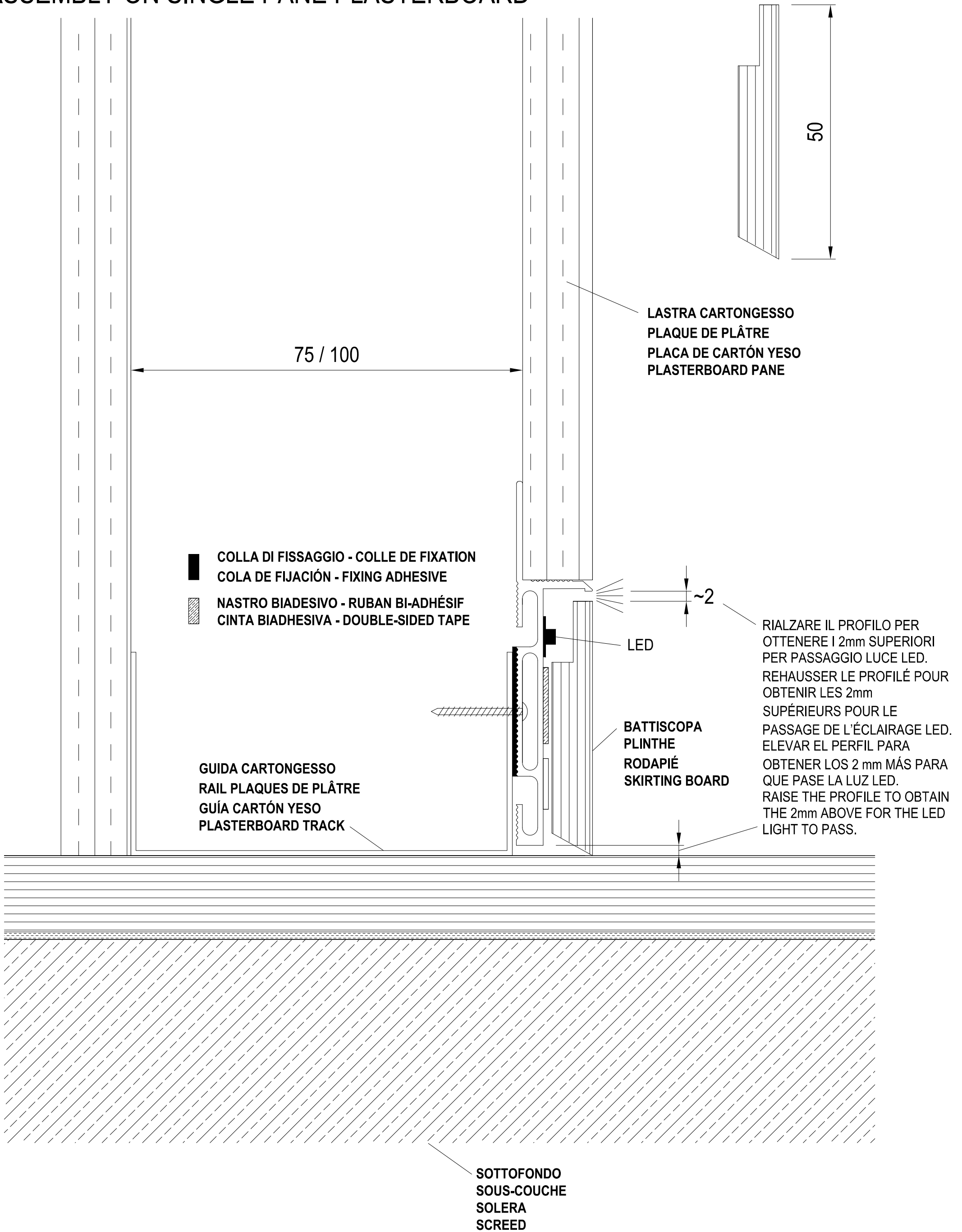

MONTAGGIO CON CARTONGESSO LASTRA DOPPIA
MONTAGE AVEC PLAQUES DE PLAQUES DE PLÂTRE PLAQUE DOUBLE
MONTAJE CON CARTÓN YESO PLACA DOBLE
ASSEMBLY ON DOUBLE PANE PLASTERBOARD

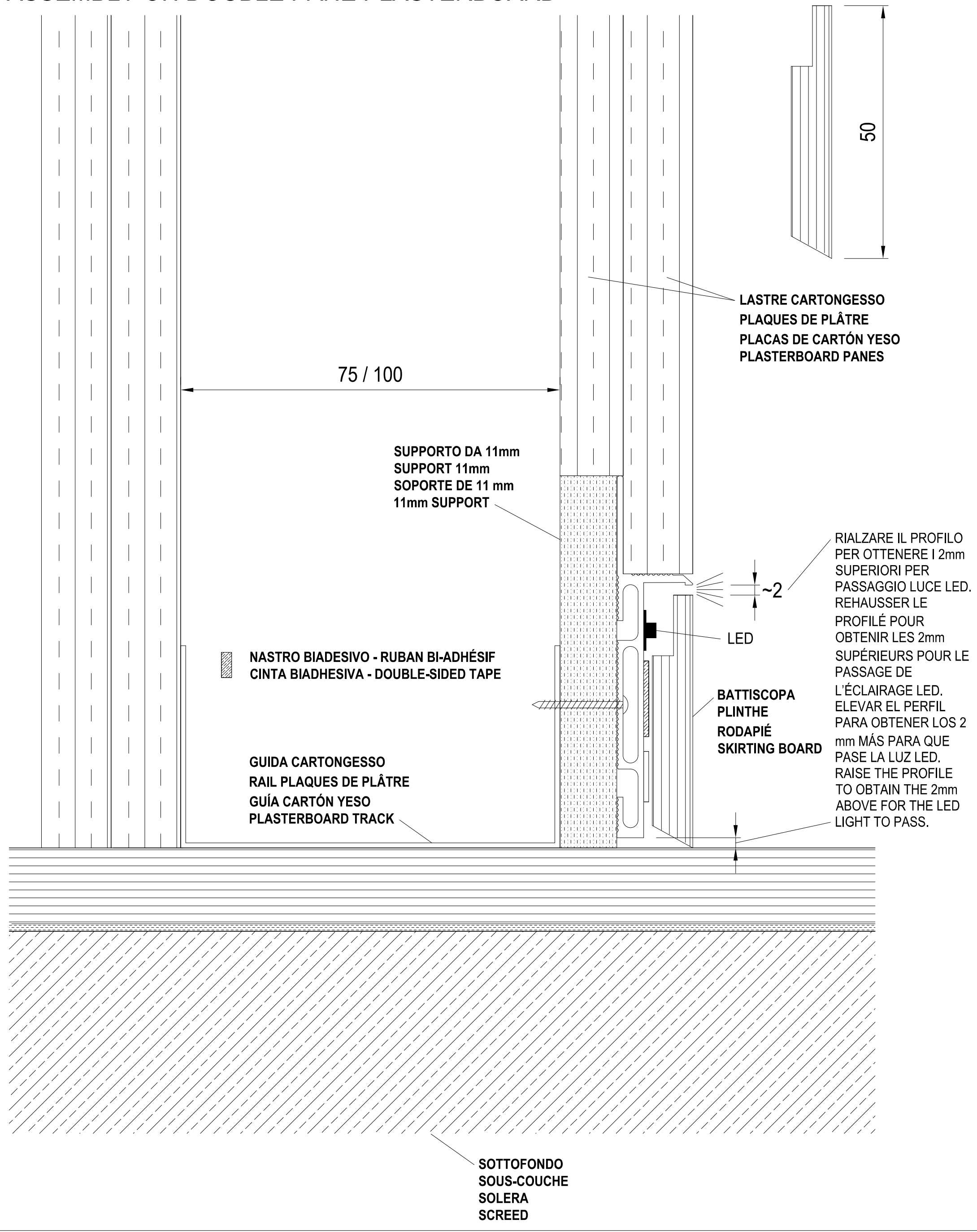

ESEMPI APPLICATIVI - EXEMPLES D'APPLICATION - EJEMPLOS DE APLICACIÓN - APPLICATION EXAMPLES

MONTAGGIO CON FILO44 TIRARE - MONTAGE AVEC FILO44 TIRER
 MONTAJE CON FILO44 DE TIRAR - ASSEMBLY WITH FILO44 PULL



MONTAGGIO CON FILO44 SPINGERE - MONTAGE AVEC FILO44 POUSSER
 MONTAJE CON FILO44 DE EMPUJAR - ASSEMBLY WITH FILO44 PUSH



MONTAGGIO CON BATTENTE50 100c/105i TIRARE - MONTAGE AVEC BATTANTE 50 100c/105i TIRER
 MONTAJE CON BATTENTE50 100c/105e DE TIRAR - ASSEMBLY WITH SWING 50 100c/105i plus PULL

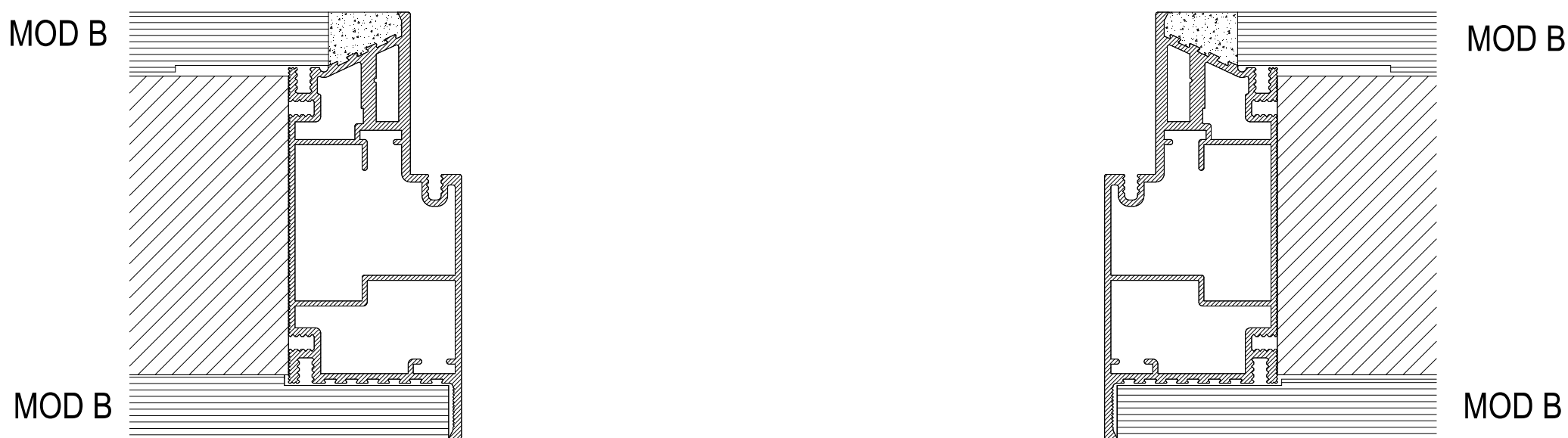

MONTAGGIO CON BATTENTE50 100c/105i SPINGERE - MONTAGE AVEC BATTANTE 50 100c/105i POUSSER
 MONTAJE CON BATTENTE50 100c/105e DE EMPUJAR - ASSEMBLY WITH SWING 50 100c/105i plus PUSH



MONTAGGIO CON BATTENTE 50 90 e oltre TIRARE - MONTAGE AVEC BATTANTE 50 90 et plus TIRER
 MONTAJE CON BATTENTE 50 90 y superior DE TIRAR - ASSEMBLY WITH SWING 50 90 and over PULL



MONTAGGIO CON BATTENTE 50 90 e oltre SPINGERE - MONTAGE AVEC BATTANTE 50 90 et plus POUSSER
 MONTAJE CON BATTENTE 50 90 y superior DE EMPUJAR - ASSEMBLY WITH SWING 50 90 and over PUSH



MONTAGGIO CON ESSENTIAL SCORREVOLE 100c - MONTAGE AVEC ESSENTIAL COULISSANTE 100c
 MONTAJE CON ESSENTIAL CORREDERO 100c - ASSEMBLY WITH ESSENTIAL SLIDING 100c

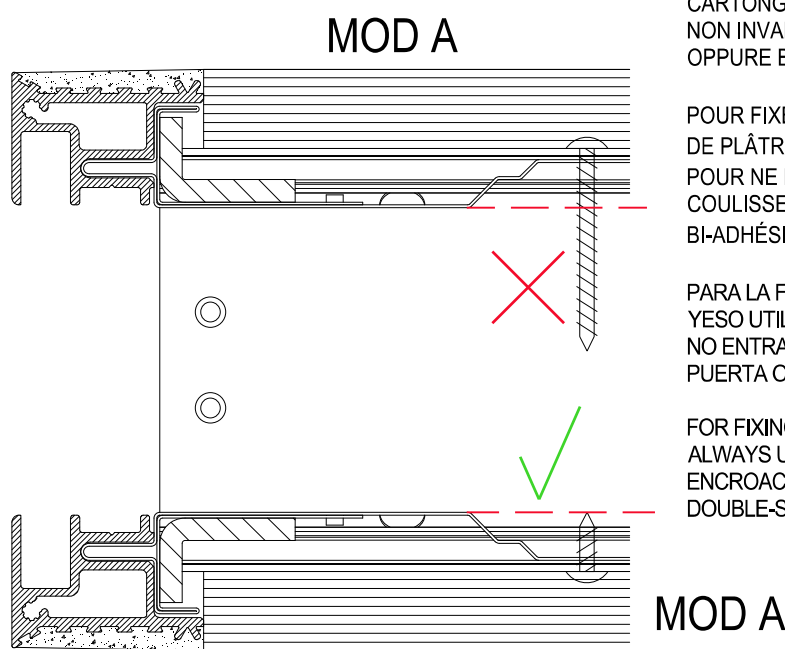
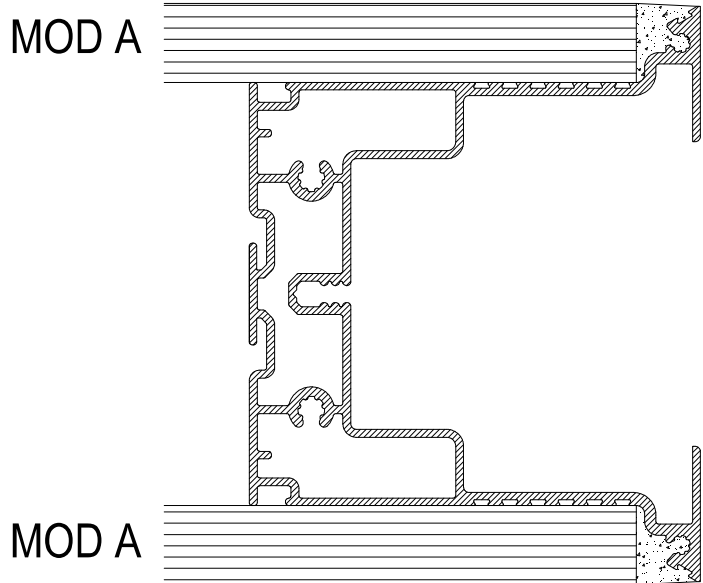

PER IL FISSAGGIO AI CONTROTELAI DA CARTONGESSO UTILIZZARE SEMPRE VITI CORTE PER NON INVADERE LA ZONA DI SCORRIMENTO ANTA OPPURE BIADESIVO O COLLA

POUR FIXER AUX CONTRE-CHÂSSIS POUR PLAQUES DE PLÂTRE, UTILISER TOUJOURS DES VIS COURTES POUR NE PAS EMPÎETER SUR LA ZONE DE COULISSEMENT DE LA PORTE OU DU RUBAN BI-ADHÉSIF OU DE LA COLLE

PARA LA FIJACIÓN A LOS PREMARCOS DE CARTÓN YESO UTILIZAR SIEMPRE TORNILLOS CORTOS PARA NO ENTRAR EN LA ZONA DE DESLIZAMIENTO DE LA PUERTA O BIADHESIVO O COLA

FOR FIXING TO PLASTERBOARD COUNTER FRAMES, ALWAYS USE SHORT SCREWS TO AVOID ENCROACHING ON THE DOOR SLIDING AREA OR DOUBLE-SIDED TAPE OR GLUE

MONTAGGIO CON ESSENTIAL SCORREVOLE INTONACO 105 / 125 - MONTAGE AVEC ESSENTIAL COULISSANTE ENDUIT 105 / 125
 MONTAJE CON ESSENTIAL CORREDERO ENLUCIDO 105 / 125 - ASSEMBLY WITH ESSENTIAL SLIDING PLASTER 105 / 125

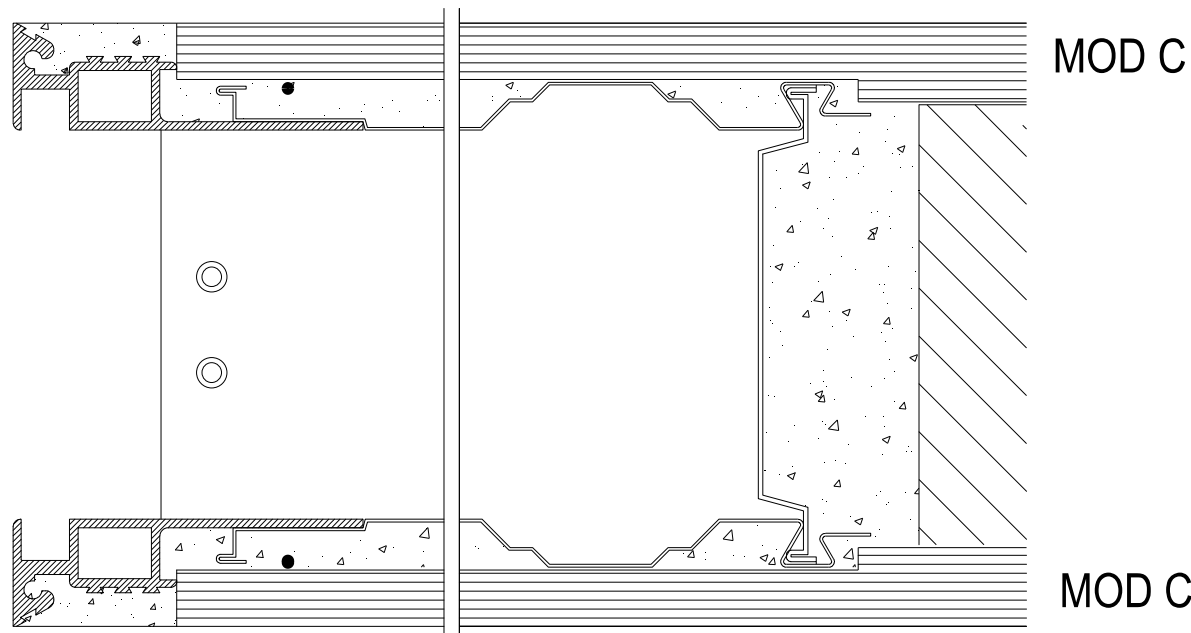
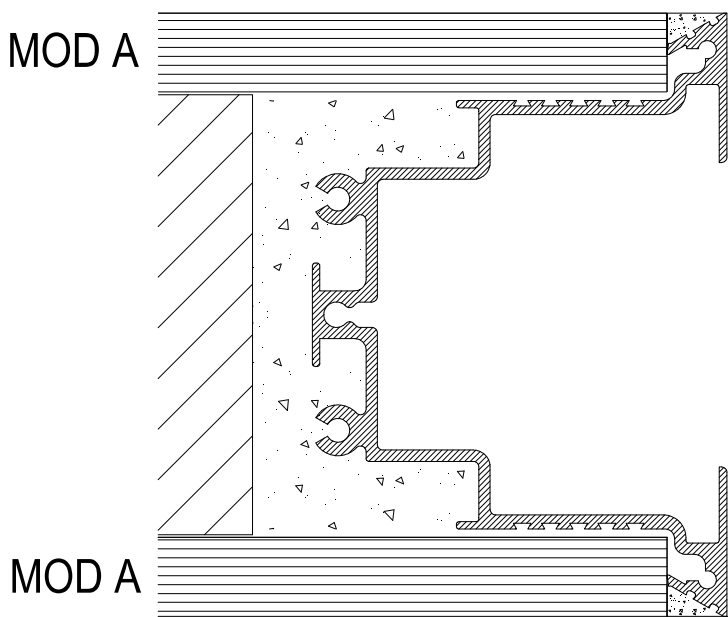

MONTAGGIO CON ESSENTIAL SCORREVOLE INTONACO 145 - MONTAGE AVEC ESSENTIAL COULISSANTE ENDUIT 145
 MONTAJE CON ESSENTIAL CORREDERO ENLUCIDO 145 - ASSEMBLY WITH ESSENTIAL SLIDING PLASTER 145

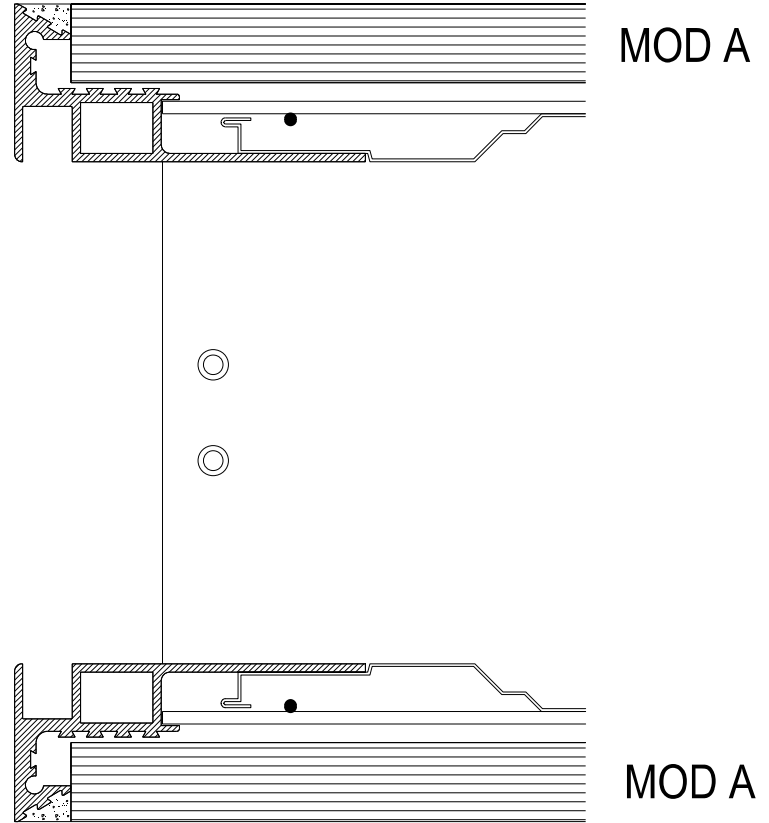
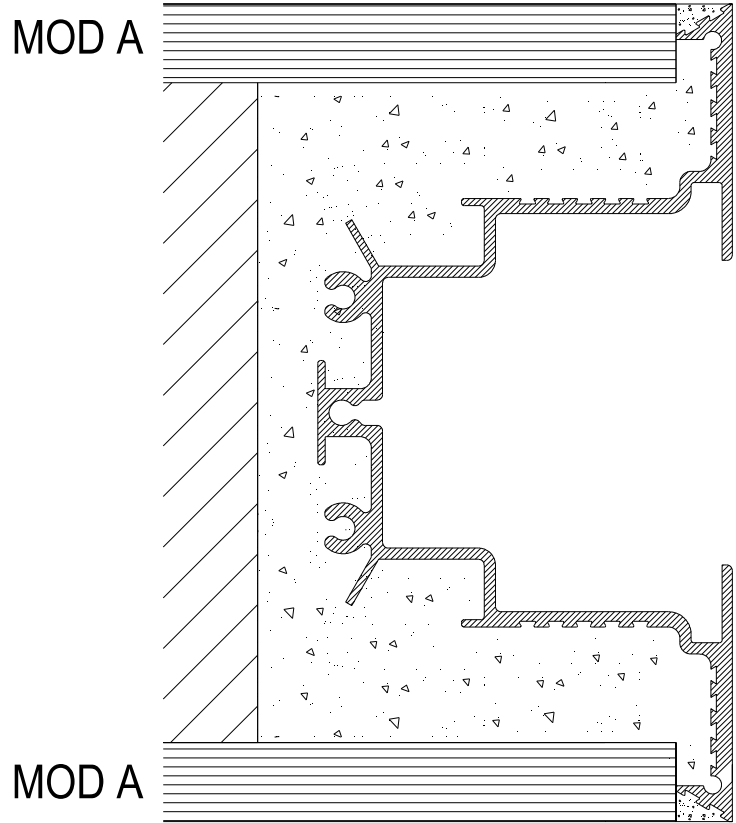

MONTAGGIO CON ESSENTIAL SCORREVOLE 125c - MONTAGE AVEC ESSENTIAL COULISSANTE 125c
 MONTAJE CON ESSENTIAL CORREDERO 125c - ASSEMBLY WITH ESSENTIAL SLIDING 125c

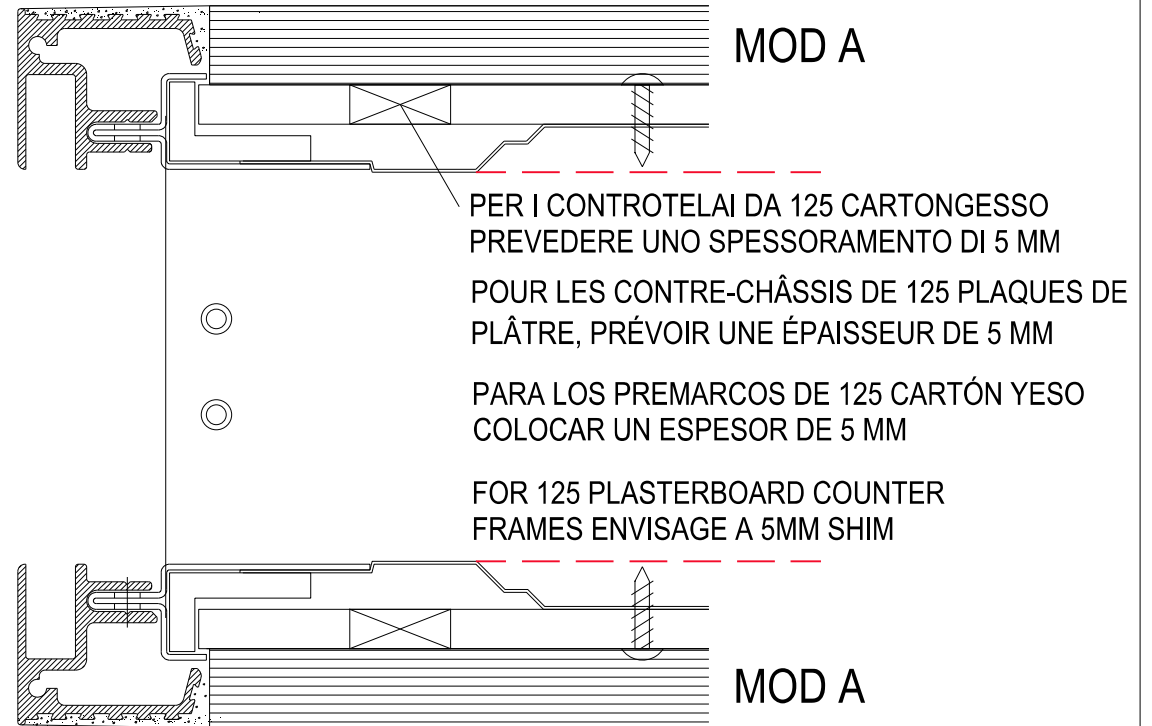
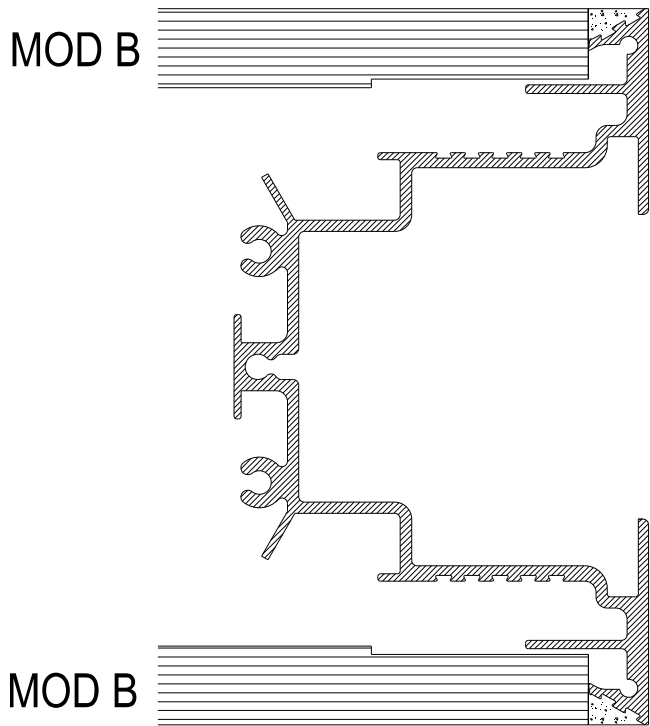

MONTAGGIO CON ESSENTIAL SCORREVOLE 125c 2L - MONTAGE AVEC ESSENTIAL COULISSANTE 125c 2L
 MONTAJE CON ESSENTIAL CORREDERO 125c 2L - ASSEMBLY WITH ESSENTIAL SLIDING 125c 2L

